

DOE Challenge Home

- Tech Training Webinar Series

U.S. DEPARTMENT OF
ENERGY

Energy Efficiency &
Renewable Energy



Efficient Hot Water Distribution I – What's at Stake



The Home of the Future....Today

U.S. DEPARTMENT OF **ENERGY** | Energy Efficiency & Renewable Energy

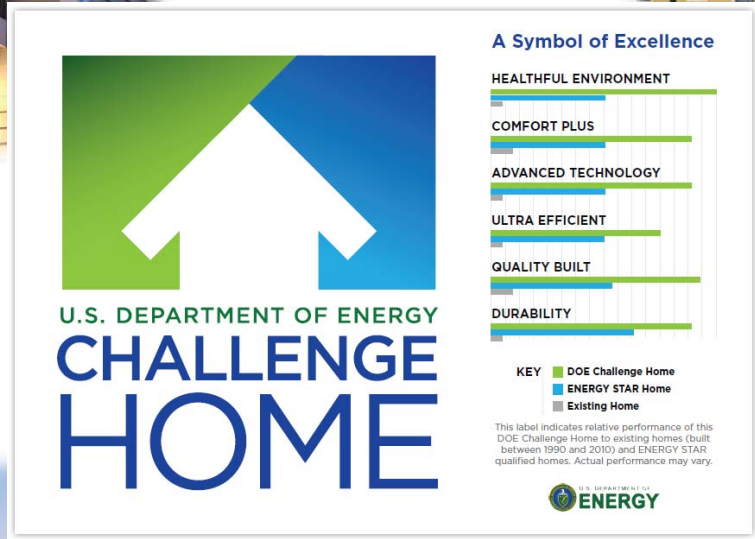

Website

- www.buildings.energy.gov/challenge/
- Events:
 - Upcoming in-person ZERH Training
 - Technical Training webinars
- Partner Locator
- Program Specifications
- Webinar Recordings (coming soon)

Building America Solution Center

- <http://basc.pnnl.gov/>

The screenshot shows the DOE Challenge Home website. At the top, it features the U.S. Department of Energy logo and the text 'Energy Efficiency & Renewable Energy'. Below this is the 'Building Technologies Office' header with navigation tabs for HOME, ABOUT, EMERGING TECHNOLOGIES, RESIDENTIAL BUILDINGS (highlighted), COMMERCIAL BUILDINGS, and APPLIANCE EQUIPMENT STANDARDS. A breadcrumb trail reads 'EERE > Building Technologies Office > Residential Buildings'. The main content area is titled 'DOE Challenge Home' and includes a paragraph explaining the program's history and goals. To the left is a sidebar menu with categories like 'About', 'Take Action to Save Energy', 'Partner With DOE', 'Activities', 'Solar Decathlon', 'Building America', 'Home Energy Score', 'Home Performance with ENERGY STAR', 'Better Buildings Neighborhood Program', 'Challenge Home' (with sub-items: Partner Log In, Become a Partner, Criteria, Partner Locator, Resources, Housing Innovation Awards, Events), 'Guidelines for Home Energy Professionals', and 'Technology Research, Standards, & Codes'. On the right, there are four featured boxes: 'Find partners & homes' (with a magnifying glass icon), 'Technical Resources' (with a 'PERFORMANCE' chart icon), 'Become a Partner' (with a 'CHALLENGE HOME PARTNER' logo icon), and 'Resources' (with a smartphone icon).

DOE Challenge Home

- Efficient Hot Water Distribution

- Based on EPA WaterSense Specifications:
 - No more than 0.5 gallons of water in any piping/manifold between the hot water source and any hot water fixture.
 - No more than 0.6 gallons of water shall be collected from the hot water fixture before hot water delivered.
 - Recirculation systems based only on a timer or a temperature sensor don't qualify
- Water heater efficiency (ENERGY STAR Level) is addressed in the Target Home
- Performance and system efficiency involve the inter-related components of the water heater, the distribution system, and the flow rates.....

Thank You



**Efficient Hot Water
Distribution II – How
to Get it Right**

**Thursday January 30,
Noon – 1 p.m. Eastern**

For More Information:

www.buildings.energy.gov/challenge/

Email:

doechallengehome@newportpartnersllc.com

Efficient Hot Water Distribution

Part 1 – What's at Stake

DOE Challenge Home Tech Training Webinars

Gary Klein

Affiliated International Management, LLC.

P.O. Box 11752

Newport Beach, CA 92658-5040

Tel: 916-549-7080

Email: gary@aim4sustainability.com

Learning Objectives

1. Understand the relative size of water heating compared to other energy uses and to our budgets.
2. Learn about the magnitude and variability of hot water use patterns.
3. Know the meaning of the terms: “time-to-tap”, “volume-until-hot” and “it’s all about the feel”.
4. Compare the Challenge Home criteria to these performance metrics.
5. Gain insights into what it takes to increase customer satisfaction.

Table of Contents

- How Big is **Hot Water**?
- The Key Components of a **Hot Water** System
- What are Residential **Hot Water** Use Patterns?
- Integrating these Components into an Effective System
- Incorporating High Performance **Hot Water** Systems into Our Buildings
- Summary

How Big is Hot Water?

Annual Energy Use for **Hot Water**?

Residential

- Single family or individual units in multi-family
 - 10-20 gallons per person per day
 - Large variations within and between households
- Annual costs for a US median household of 3:
 - Approximately \$150-300 – natural gas
 - Approximately \$500-1,000 – electric resistance or propane
 - Variations depend on temperature rise, water heater or boiler efficiency and fuel price
 - What would operating a heat pump water heater cost?
 - A condensing gas water heater or boiler?
 - Approximately \$130 for water and sewer combined

How Big is Hot Water?

Water heating is the 1st or 2nd largest residential energy end-use: 15 – 30% of a house's total energy pie.

- What is number 1? Number 3?
- Percentage grows as houses and appliances get more efficient

How does this compare to your:

- Cell phone bill?
- Internet bill?
- Cable or Satellite bill?
- Designer coffee bill?

Why Do I Work on Hot Water?

- Energy Intensity of Indoor Cold Water
 - Range from 5 to 25 kWh per 1000 gallons
- Energy Intensity of Hot Water

	Electric		Natural Gas	
	Resistance (85% Efficient)	Heat Pump (COP=2)	50% Efficient	95% Efficient
kWh/1,000 Gallons	101	85	42	80
Relative Energy Intensity compared to 5 kWh/1,000 gallons	20	17	8	16

- Typically 40-68 times more energy intensive than indoor cold water.

The most valuable water to conserve
is **hot water**
at the top of the tallest building, with
the highest elevation,
in the area with the greatest
pressure drop.

Issues We Face

- Flow rates have been reduced
- Distances to fixtures have increased
- Potential for simultaneous flow is generally overestimated
- Code requirements for minimum pipe diameters have not been revised since before flow rates were reduced
- Codes and efficiency and green programs generally focus on components, not the hot water system
- Others?

Topics for Discussion

- Fixture fitting and appliance flow rates and fill volumes
- Pipe insulation
- Volume from source of hot water to uses
- Temperature maintenance systems
- Methods of controlling circulation loops
- Drain water heat recovery
- Water heater energy and water heater efficiency
- Vary requirements by type of occupancy
- Energy rating that takes into account reduced hot water use
- Others?

What Are We Aiming For?

- People want the service of hot water, as efficiently as possible.
- It does not make sense to discuss efficiency until the desired service has been provided.

The 2 Key Services...

Hot Water Now = “Instantaneousness”

- Need hot water available before the start of each draw.
 - A tank with hot water
 - Heated pipes
- Need the source of hot water close to each fixture or appliance
- Point of Use is not about water heater size, its about location

Never Run Out in My Shower = “Continousness”

- Need a large enough tank or a large enough burner or element
- Or, a modest amount of both

The Key Components of a **Hot Water** System

The **Hot Water** System

- Treatment and Delivery to the Building
- Use in the Building
 - Water Heater
 - Piping
 - Fixtures, Fittings and Appliances
 - Behavior
 - Water Down the Drain
- Waste Water Removal and Treatment

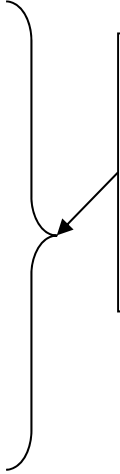

Which is the biggest **variable** in determining water and energy use?

How do the **interactions** among these components affect **system** performance?

Typical "Simple" Hot Water System

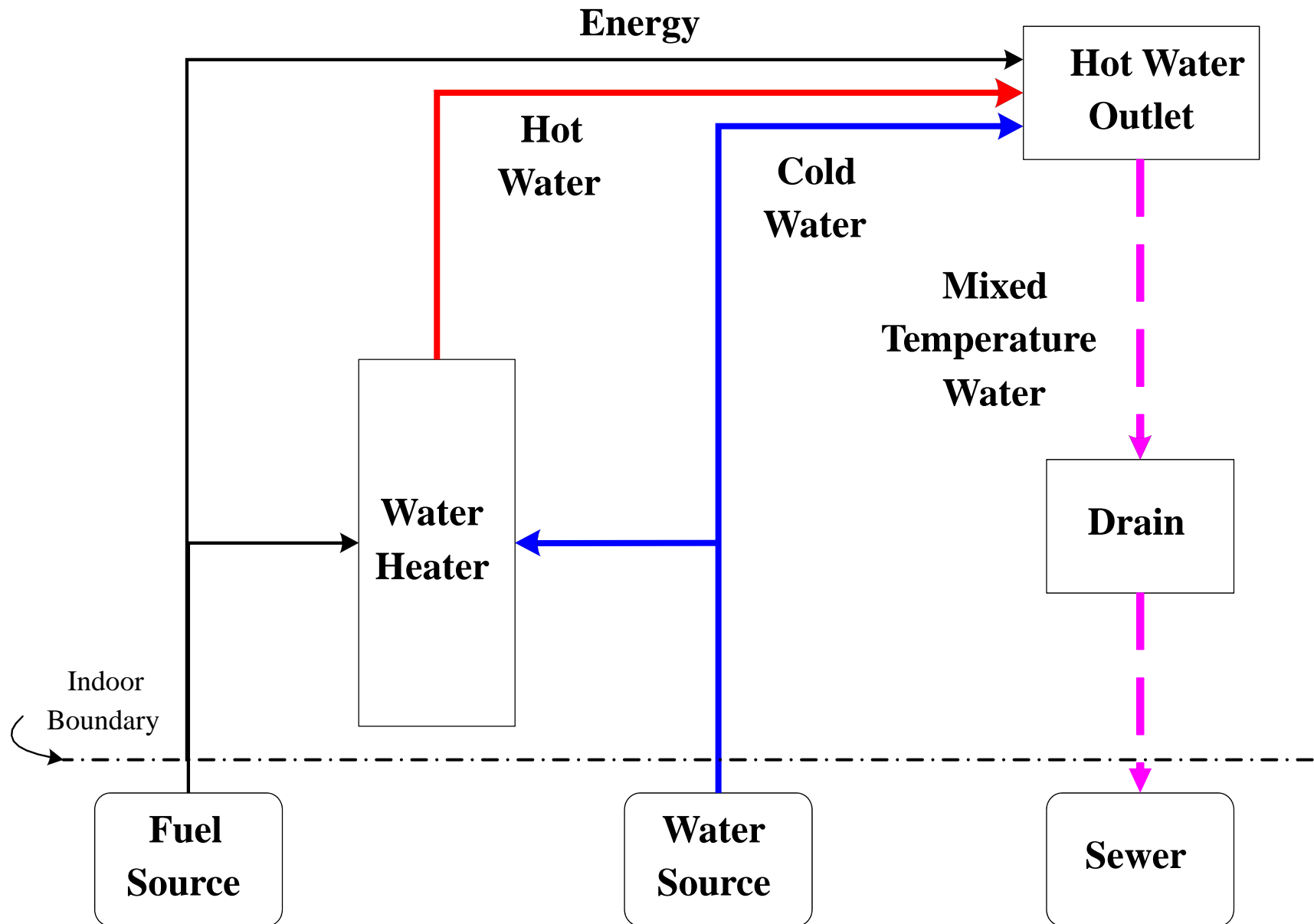

Typical Central Boiler Hot Water System

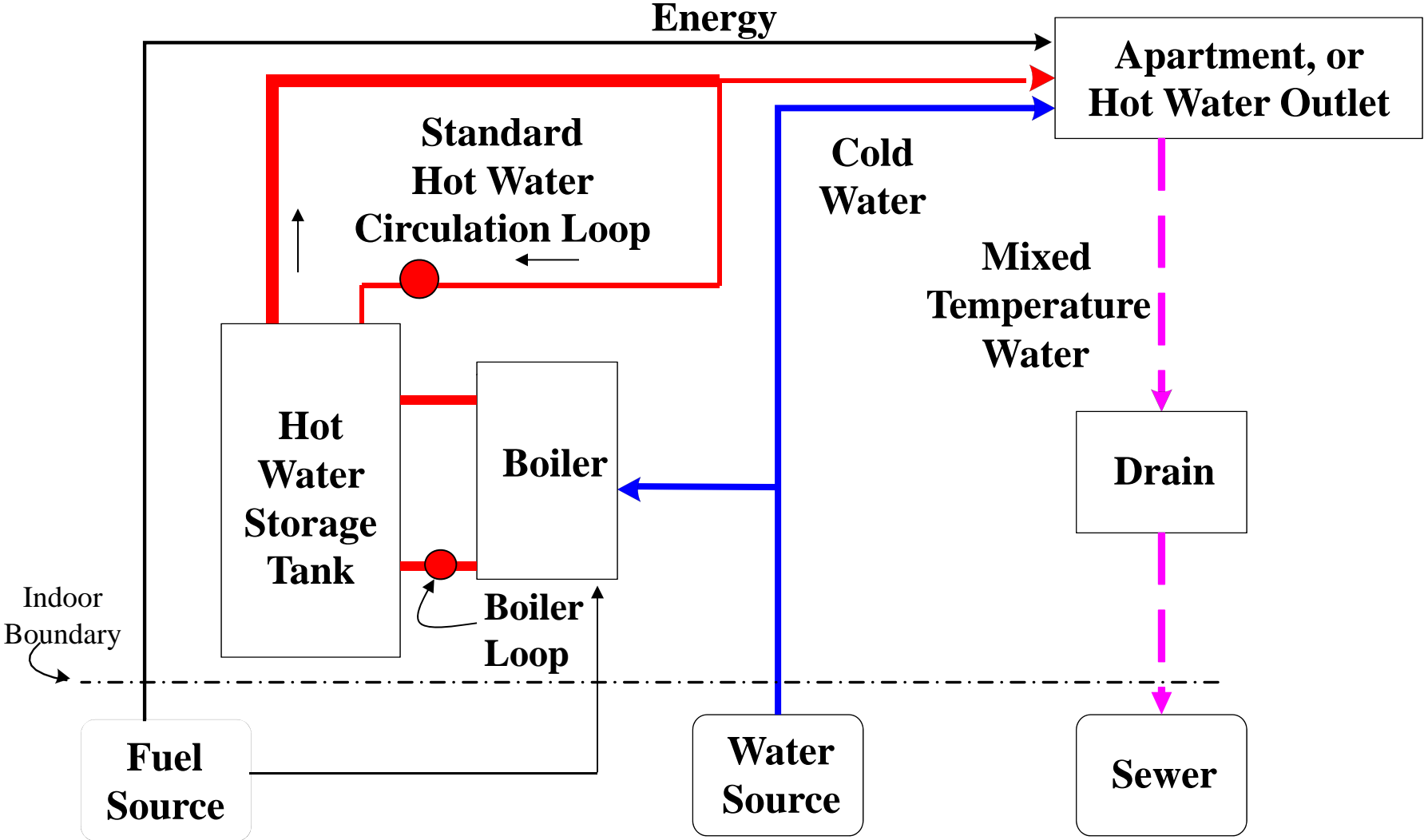

Definitions for Water Supply Piping

1. A Twig line serves one outlet or appliance.
 - The diameter of the twig should be determined by the flow rate of the outlet or appliance it serves and the pressure drop that will occur due to length, velocity and restrictions to flow (e.g. elbows and tees).
2. A Branch line serves more than one twig.
3. A Trunk line serves branches and twigs.
4. A Main line serves the building.
5. A hot water location contains one or more hot water outlets. Some cold ones too.

What are Residential **Hot Water** Use Patterns?

Do You Know:

- *Anyone who waits a long time to get hot water somewhere in their house? At their job? In their favorite restaurant?*
- Someone who has ever run out of hot water?
- *Any Communities that have a “you can’t build unless you can guarantee a long term supply of water” ordinance?*
- Someone who has a “routine” that they do while waiting for hot water to arrive at their shower? At the kitchen sink? For the dishwasher?
- *Anyone who wants instantaneous hot water?*
- Someone who thinks that a tankless water heater is instantaneous?
- *Anyone who thinks that a whole-house manifold plumbing system will save water?*
- Someone who is confused about how to implement the LEED, NAHB, Water Sense, Build-it-Green or other hot water distribution system credits?
- *Anyone who would like to learn how to get hot water to every fixture wasting no more than 1 cup waiting for the hot water to arrive?*
- Someone who wants to know “the answer”?

Typical Hot Water Event

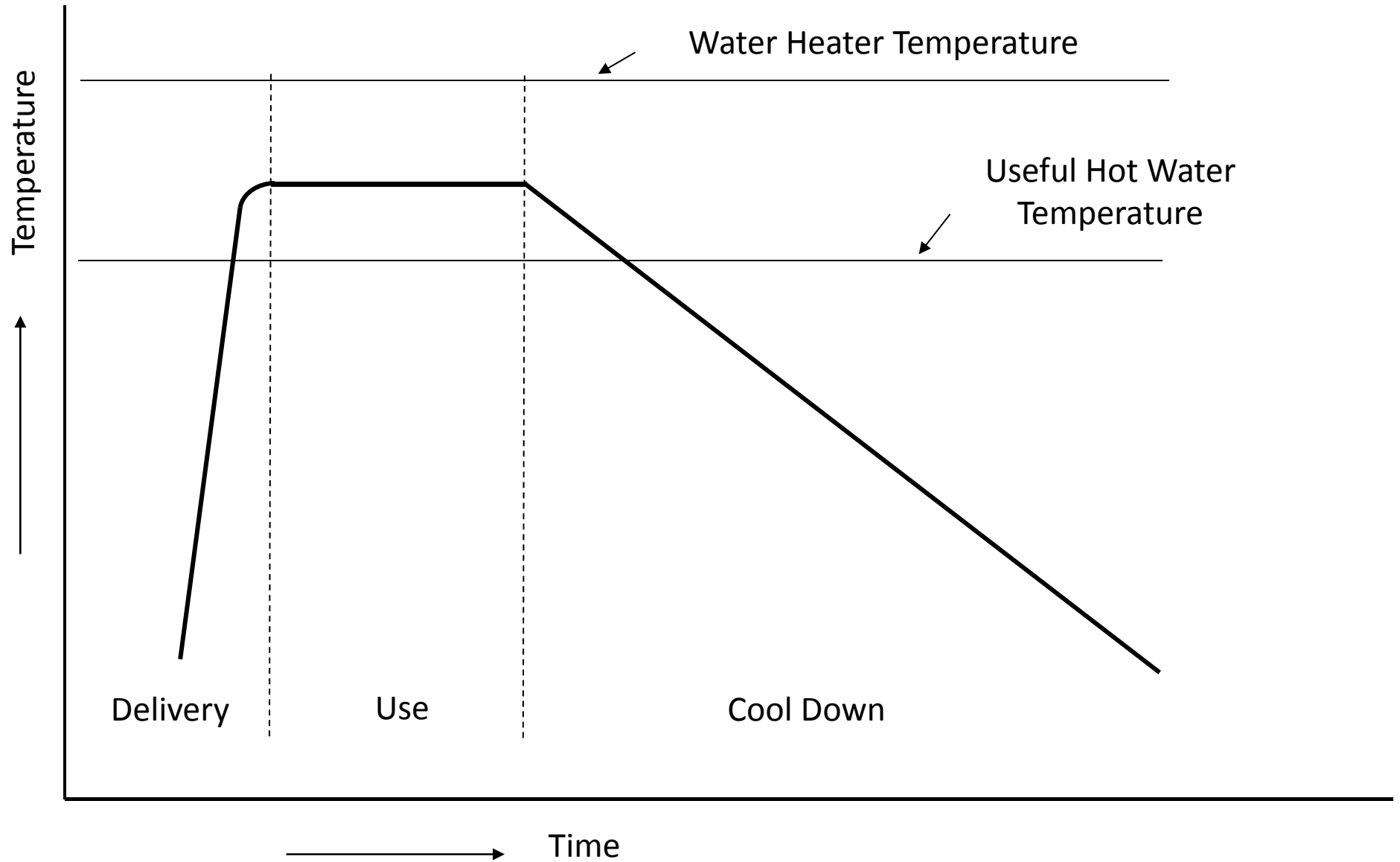

Field Studies of Hot Water Use



Summary of Field Studies

- 12 studies
- 159 monitored houses,
- 250 monitored configurations of water heaters and hot water end uses
- 22,902 days of monitoring
- 21,491 days that included inlet water temperature
- 1,679,668 hot water draws
- > 73 draws per day

Source: Jim Lutz and Moya Melody, Typical Hot Water Draw Patterns Based On Field Data, Lawrence Berkeley National Laboratory, November 2012

Draw Patterns for Water Heater Tests

DOE Test Pattern for Energy Factor

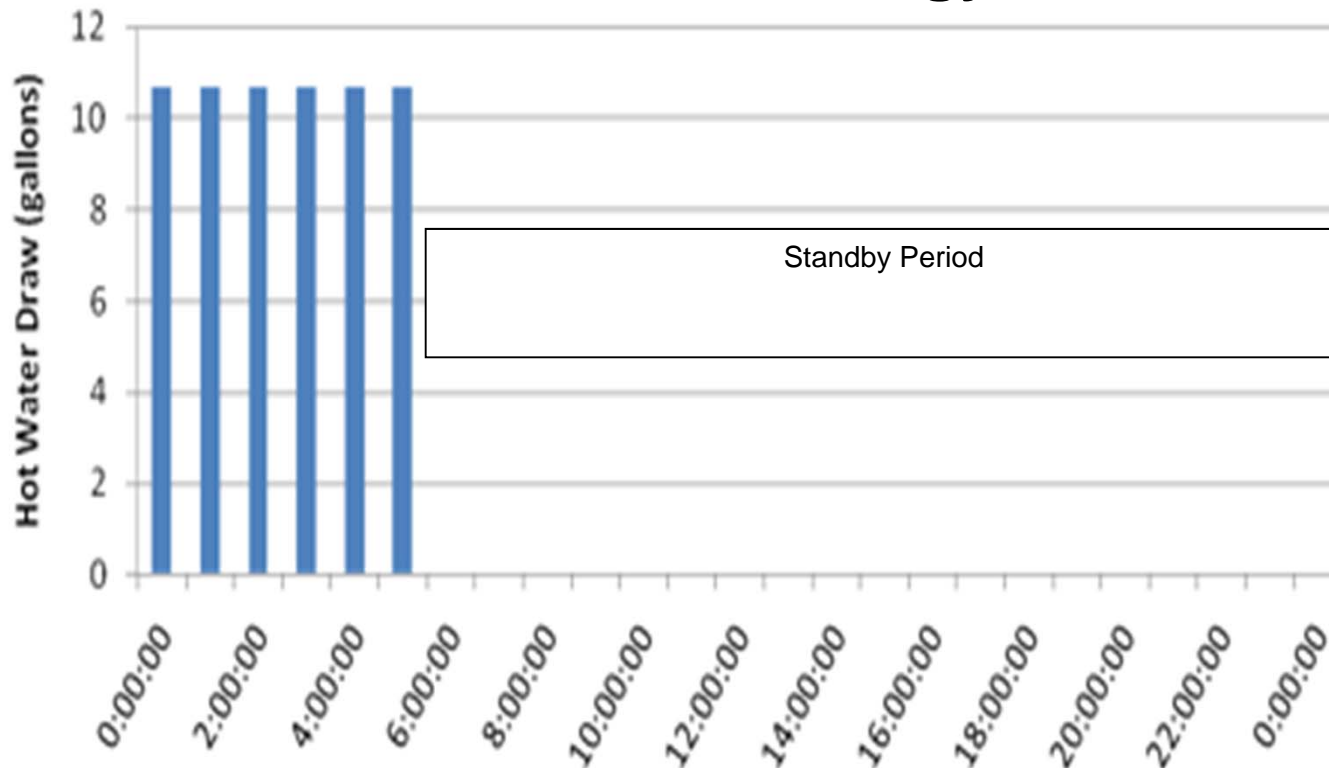

64.3 gallons per day

6 equal draws, 10.72 gallons per draw

3 gallons per minute, 3.6 minutes per draw

Daily Hot Water Use

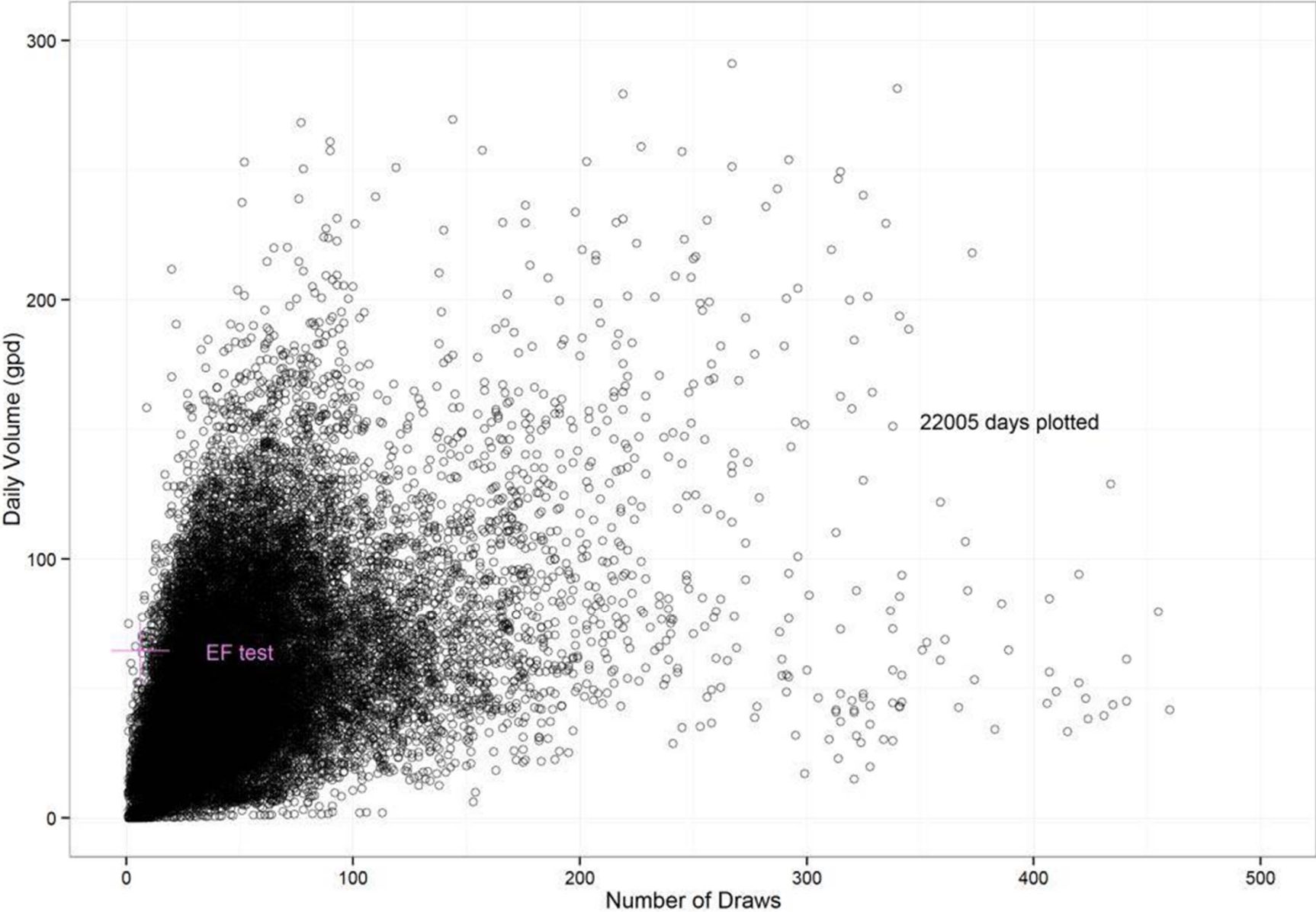

Median Daily Hot Water Use

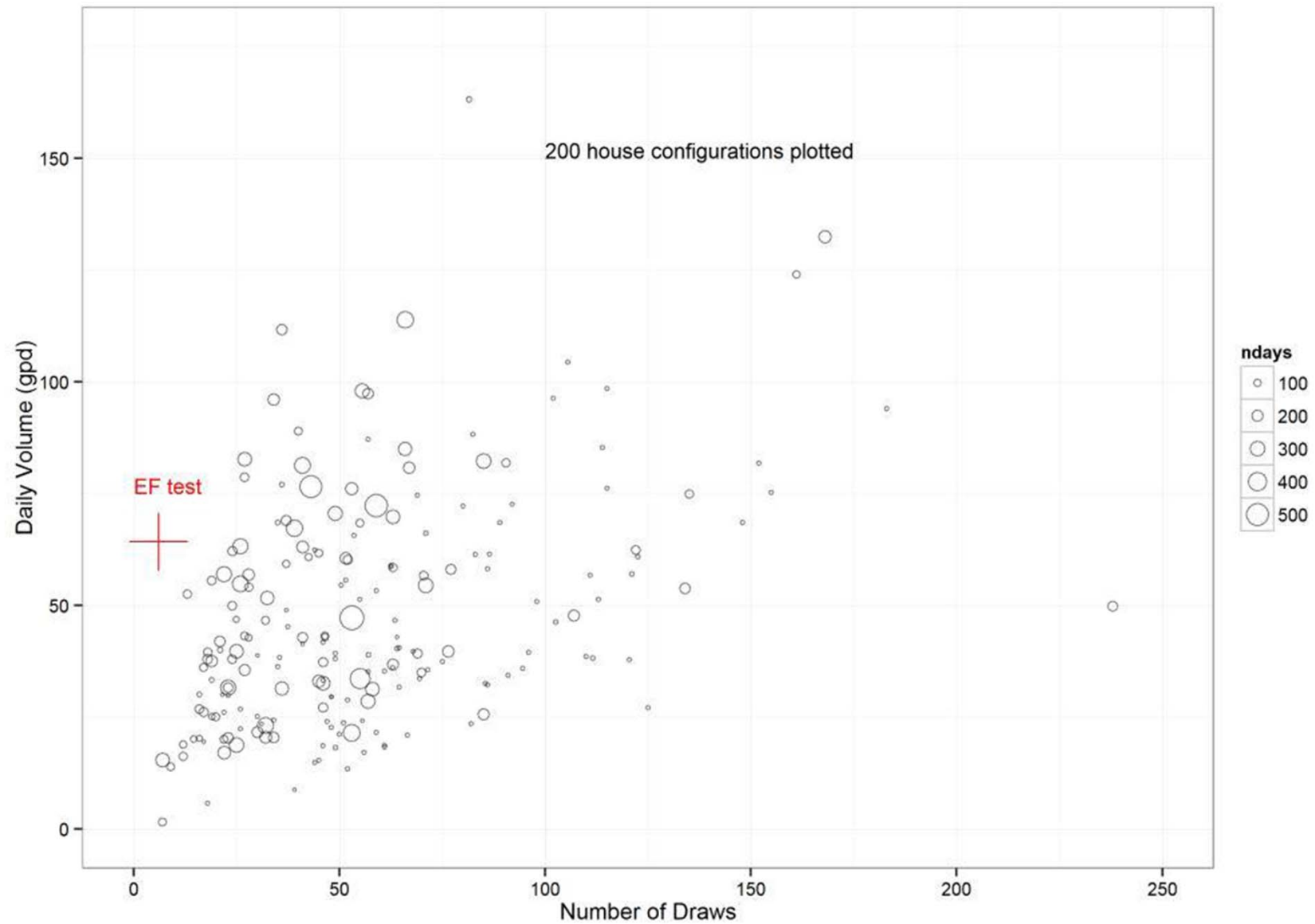

Clustered Median Daily Hot Water Use

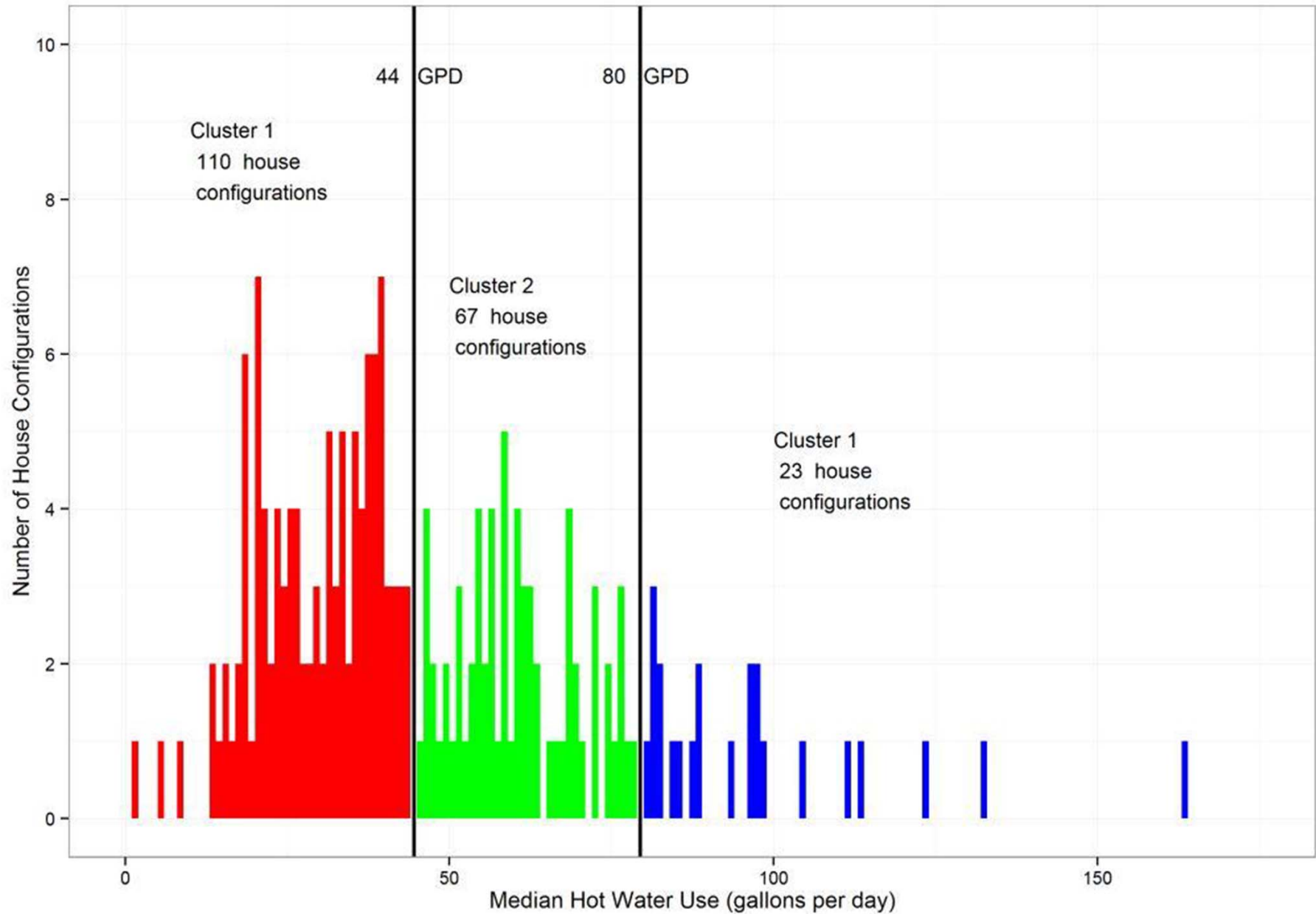

How Big are the Draws?

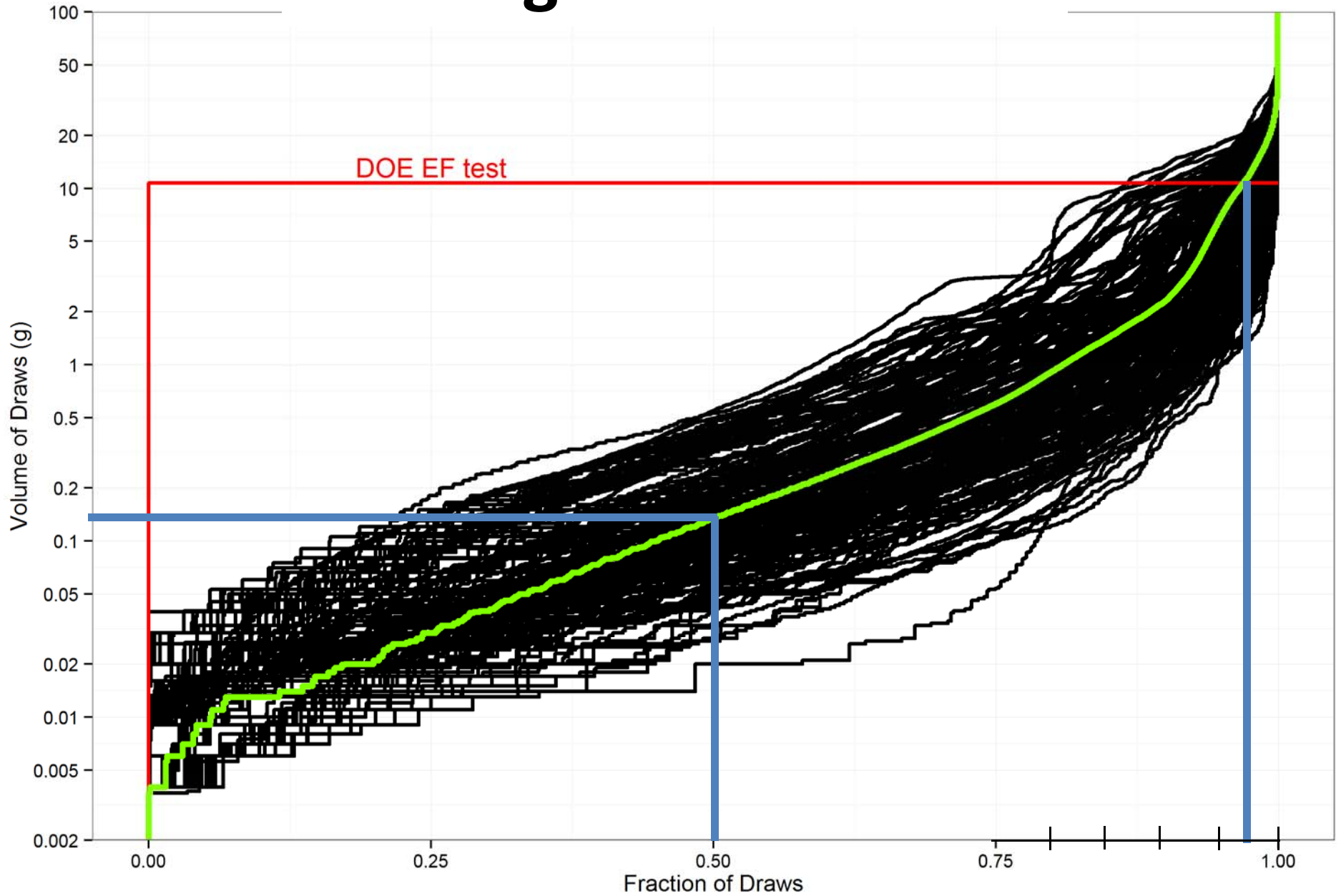

How Long is Each Draw?

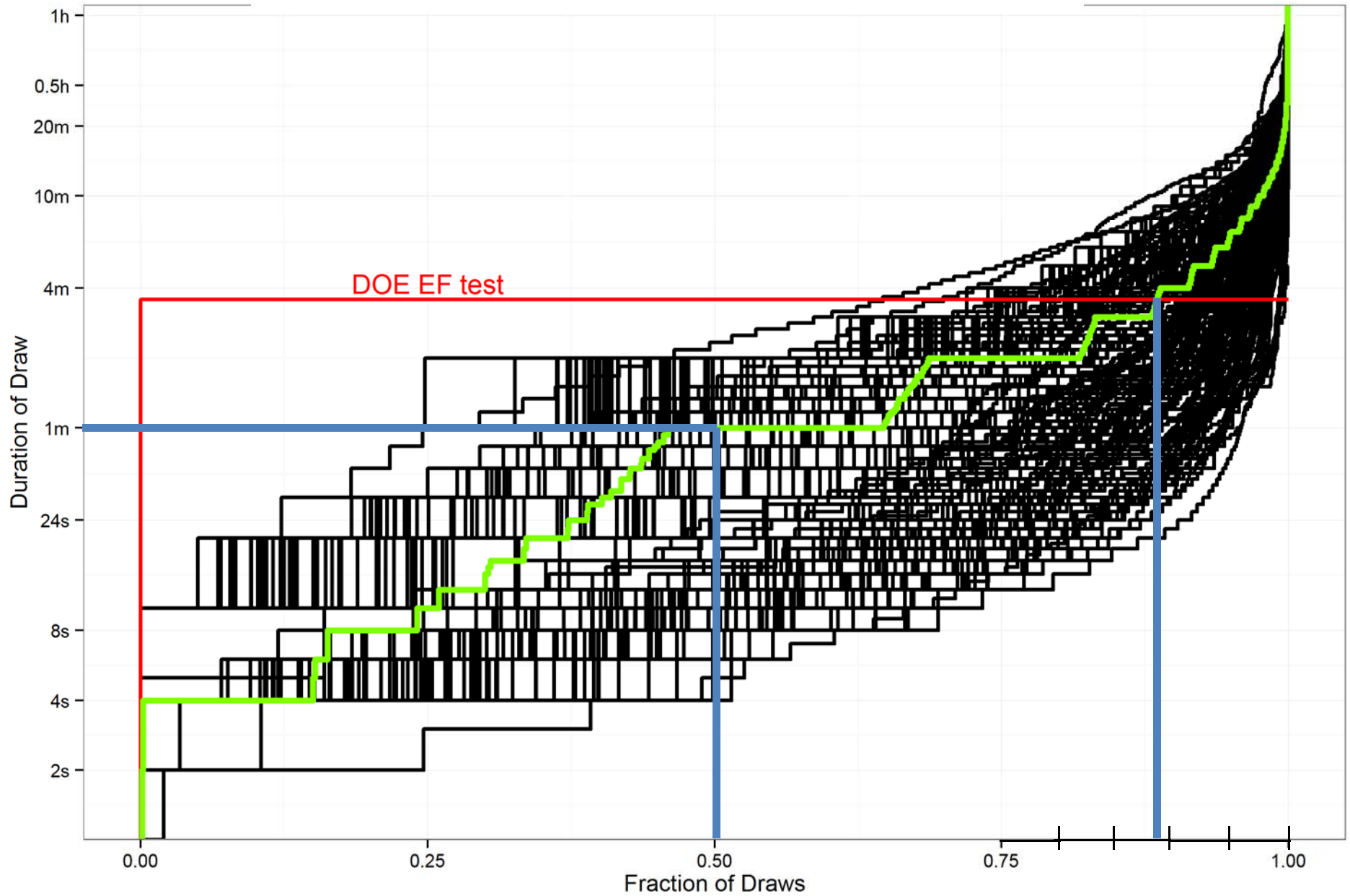

How Much Time Between Draws?

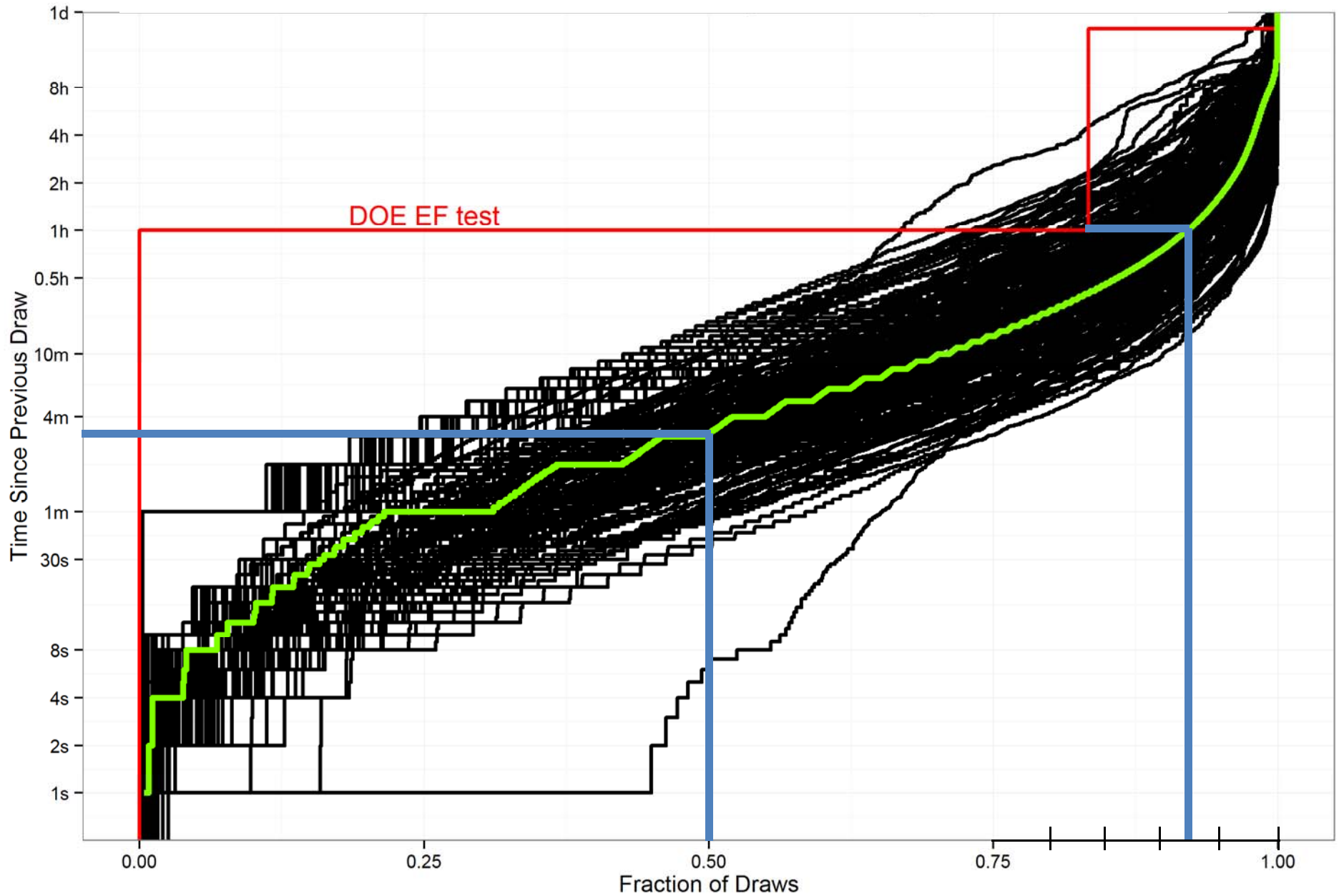

What are the Flow Rates?

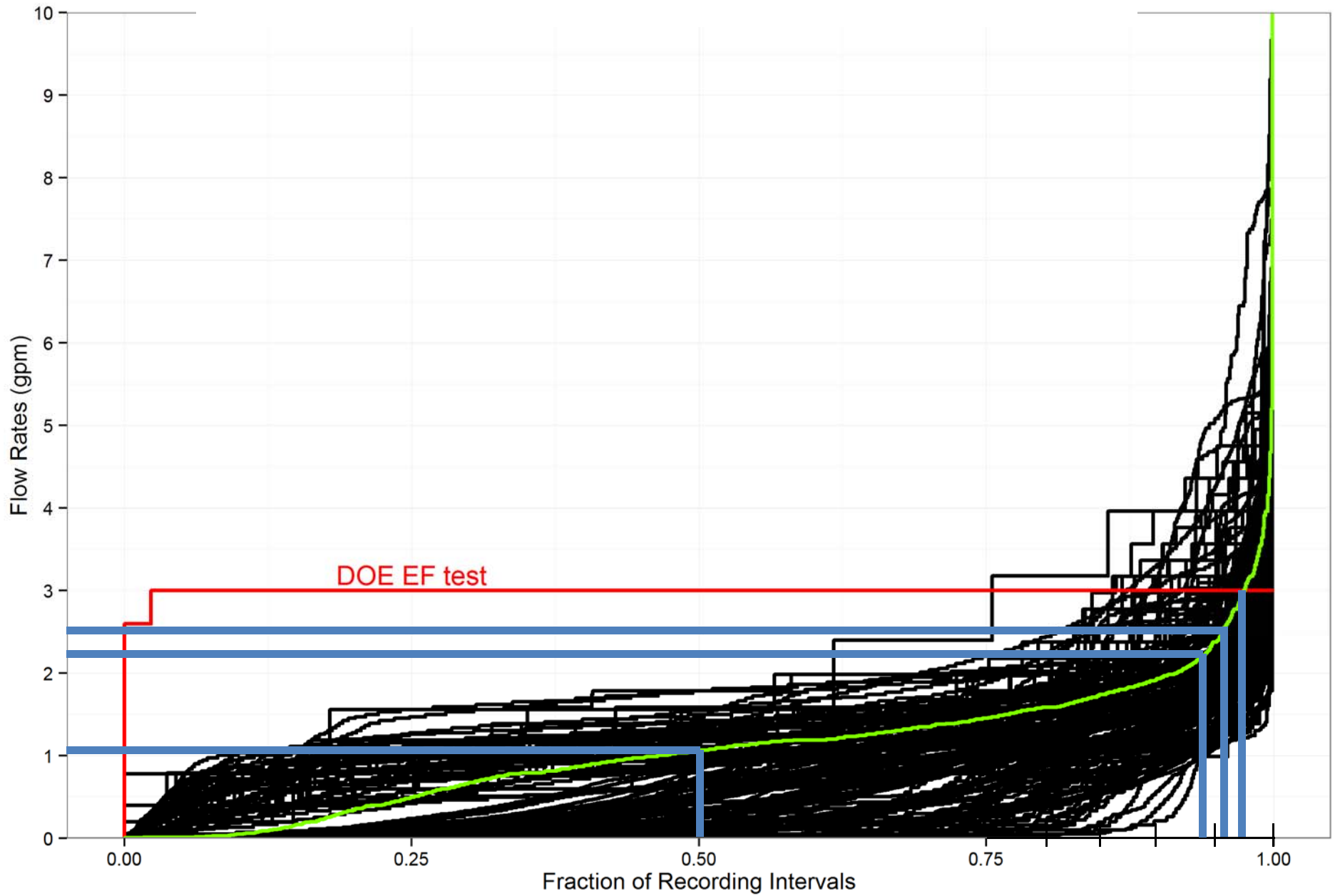

Inlet Water Temperatures

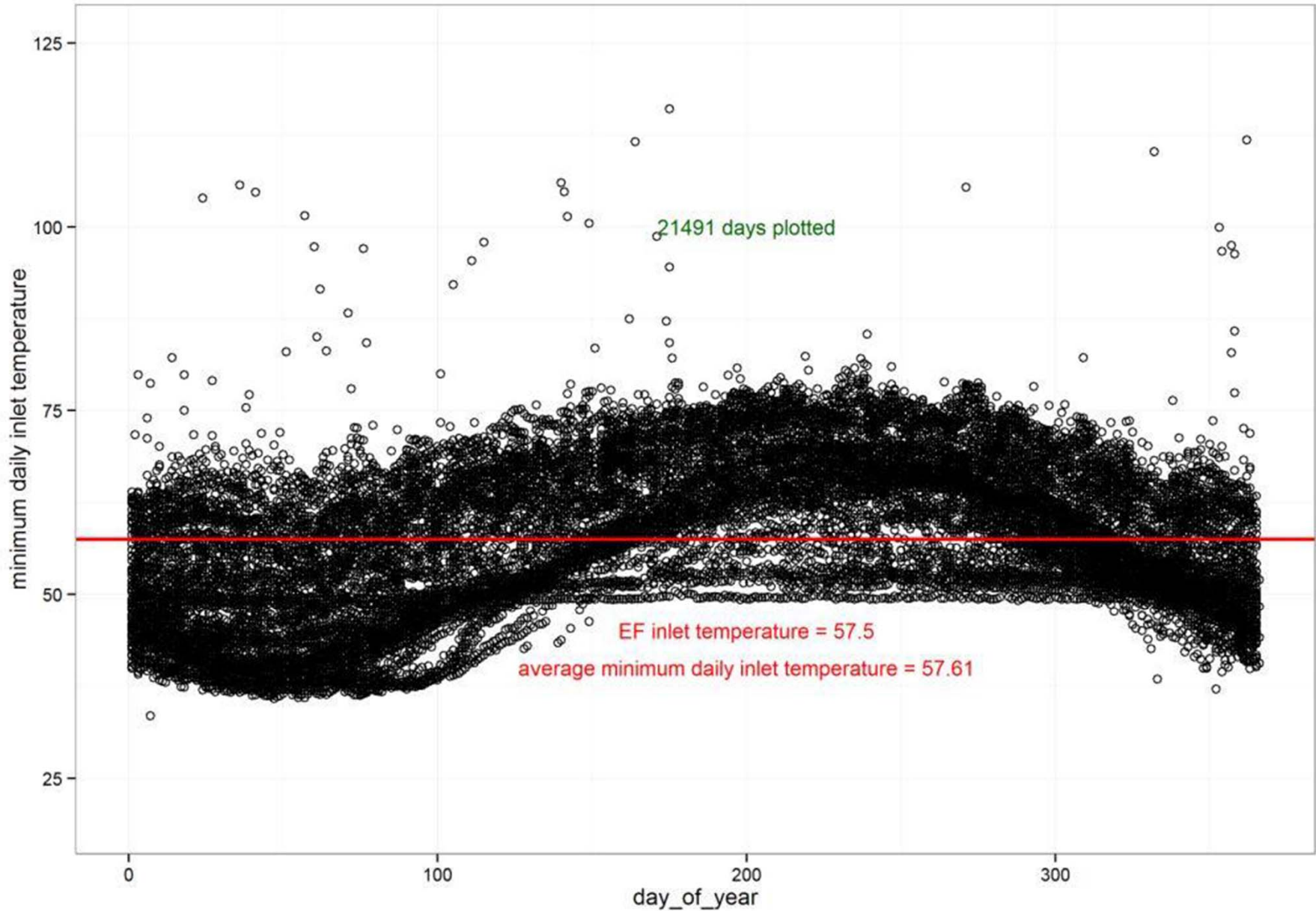

California Hot Water Research

- Residential Water Heating Program, Prime Contractor – Gas Technology Institute
- Funded by California Energy Commission, CEC 500-08-060
- 36 month study
- Field Studies – hot water use in 18 homes, distribution piping in 100 homes, surveys
- Laboratory Studies – water heaters, distribution piping

Daily Hot Water Use (Gallons)

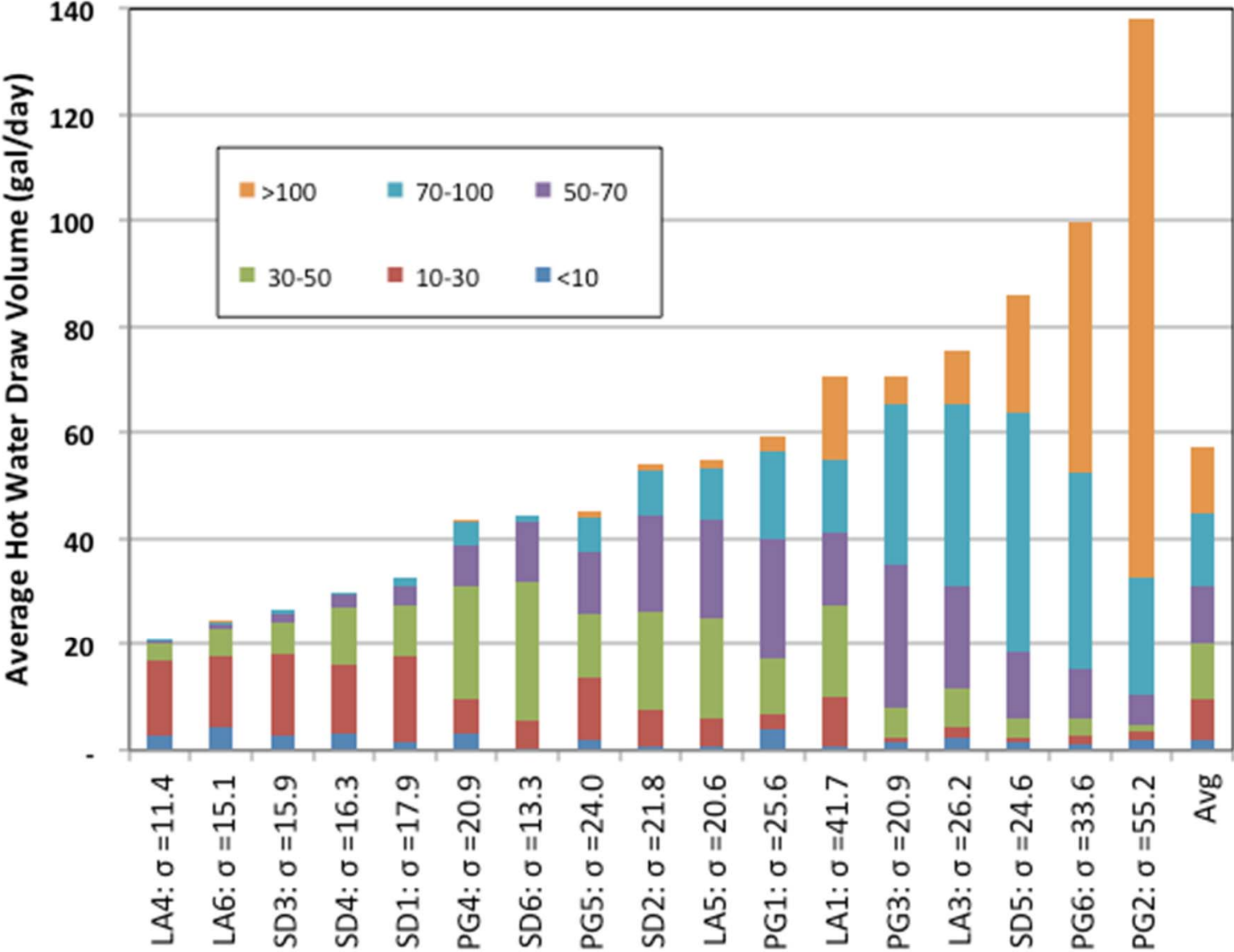

Daily Hot Water Use (Gallons)

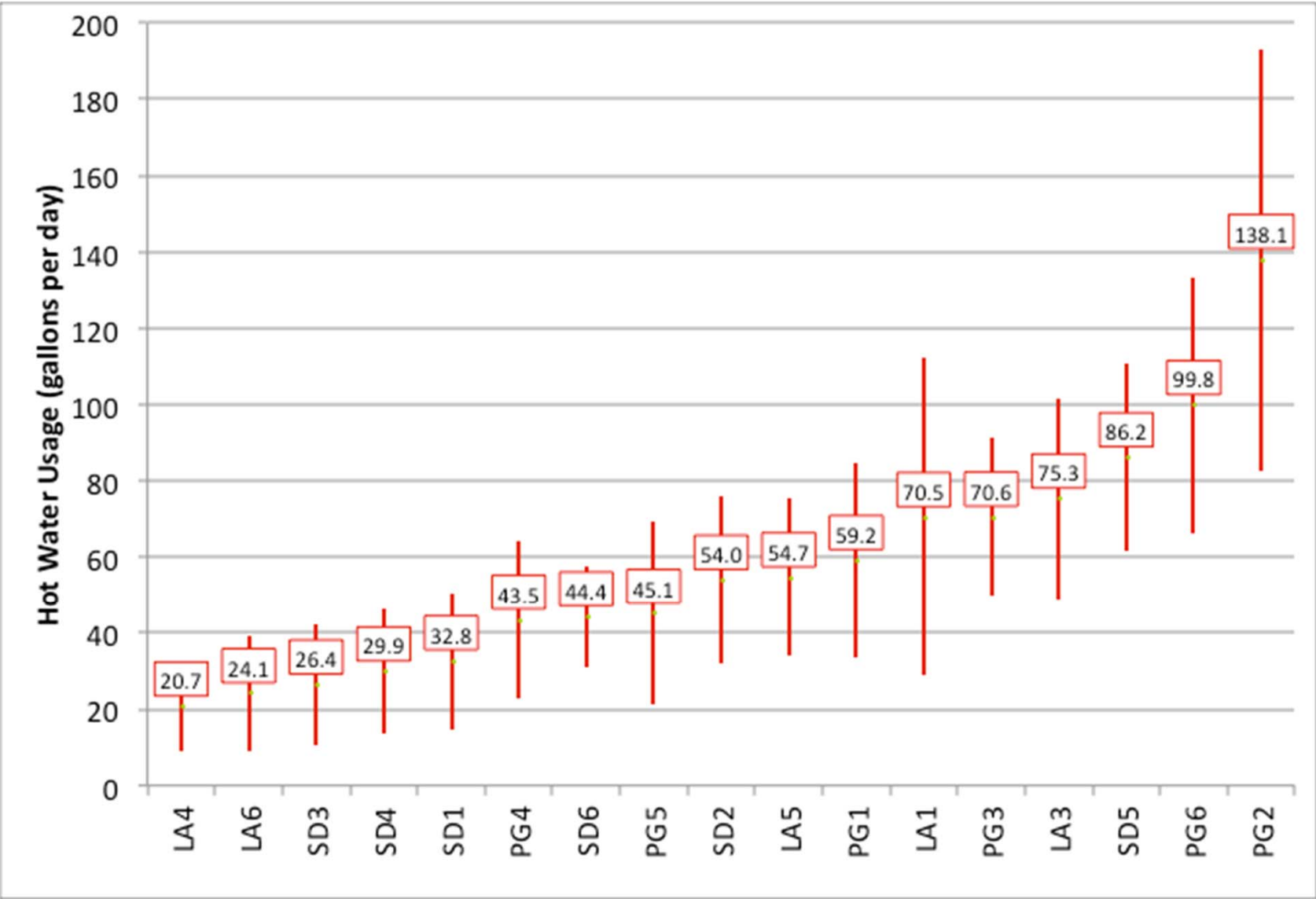

How do we use hot water?

- Frequent short, low flow-rate draws
- Occasional long draws at low flow-rates
- High flow-rate and high volume draws are rare
- Draws are highly clustered

What We Have Learned About Flow Rates, Volume-until-Hot and Time-to-Tap

Kitchen Sink Peak Flow Rate Distribution

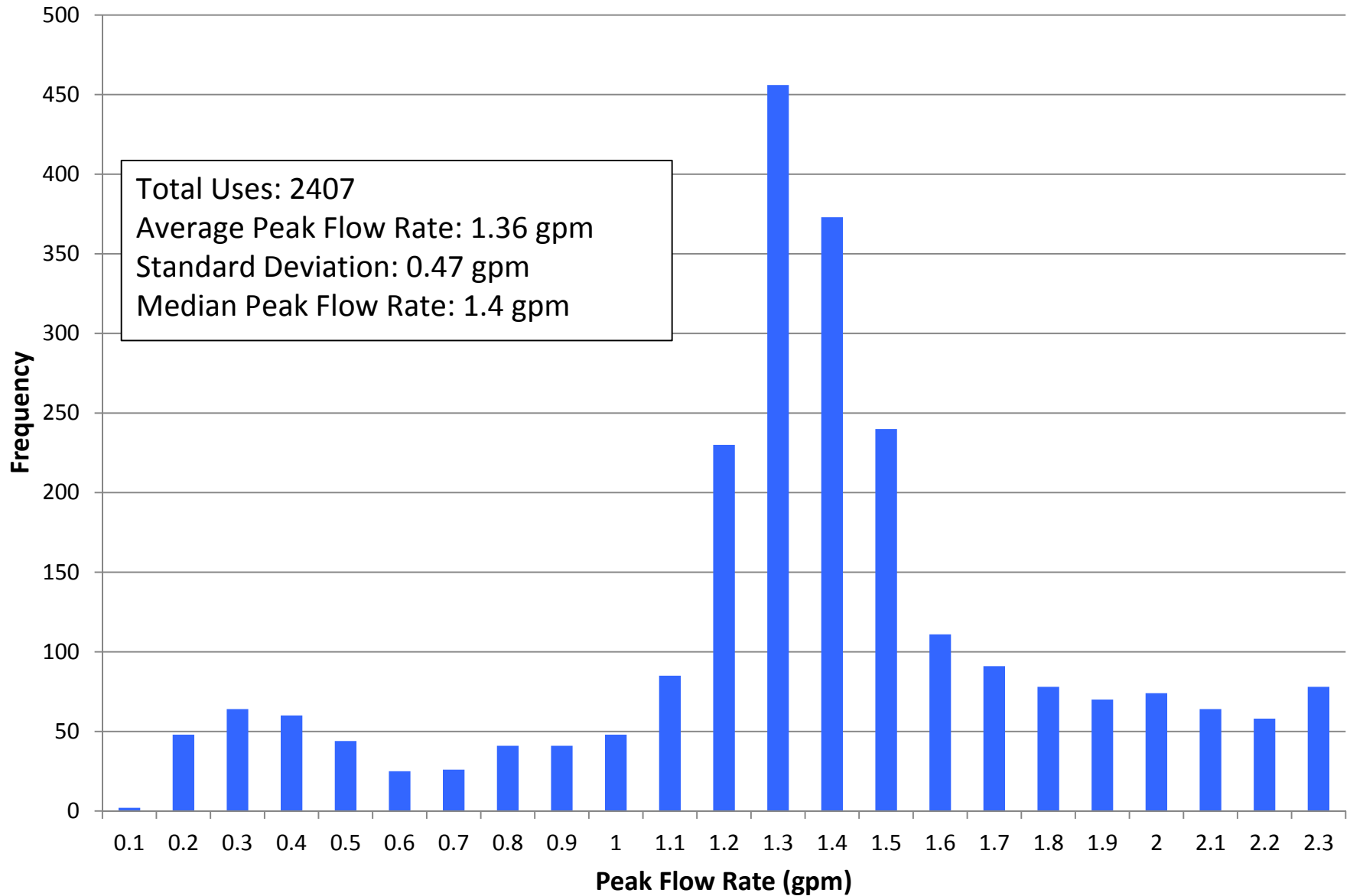

Source: Craig Selover, Masco

Lavatory Faucet Peak Flow Rate Distribution

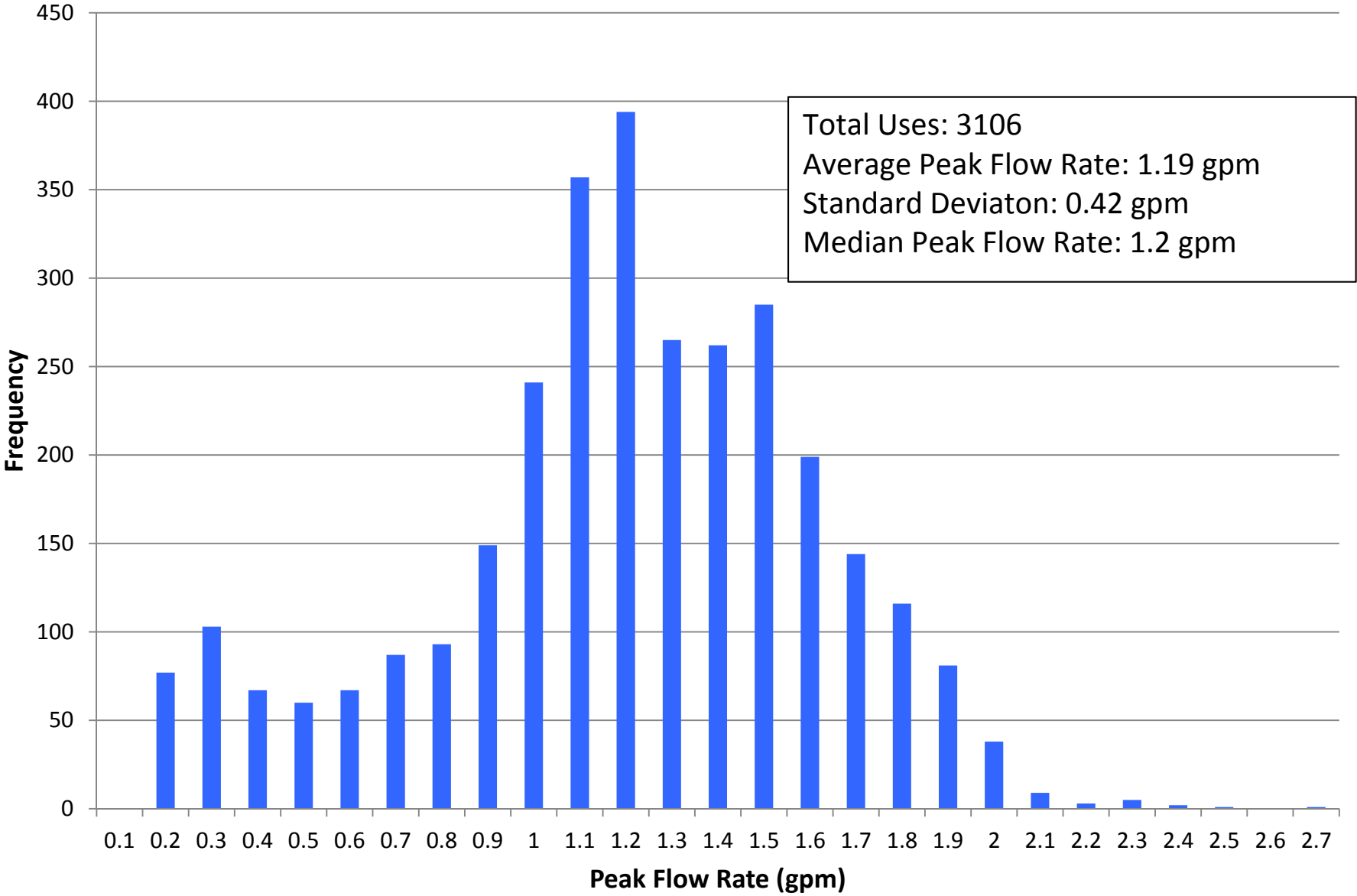

Source: Craig Selover, Masco

Shower Uses

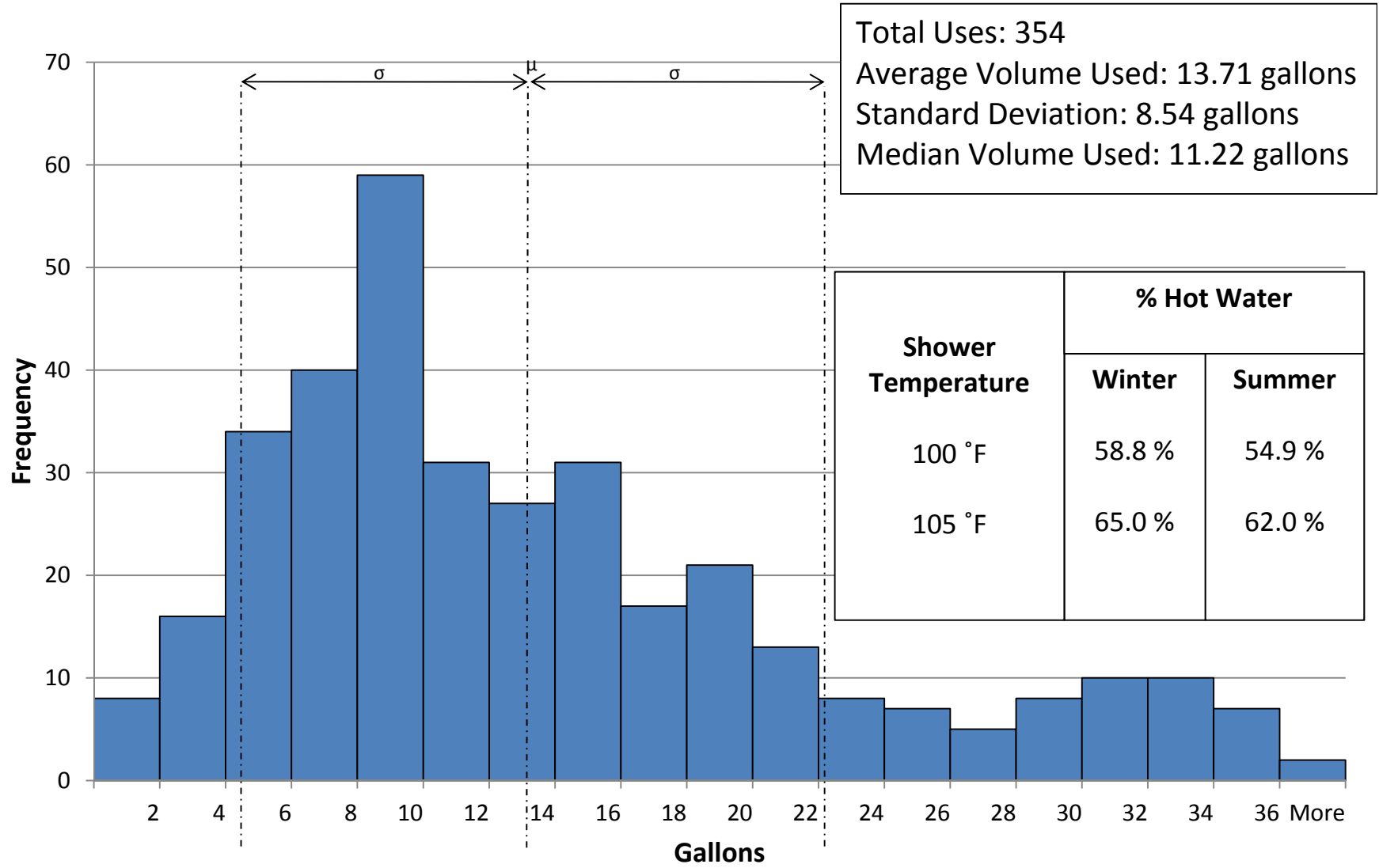

Source: Craig Selover, Masco

Time and Temperature at the Master Bath Sink

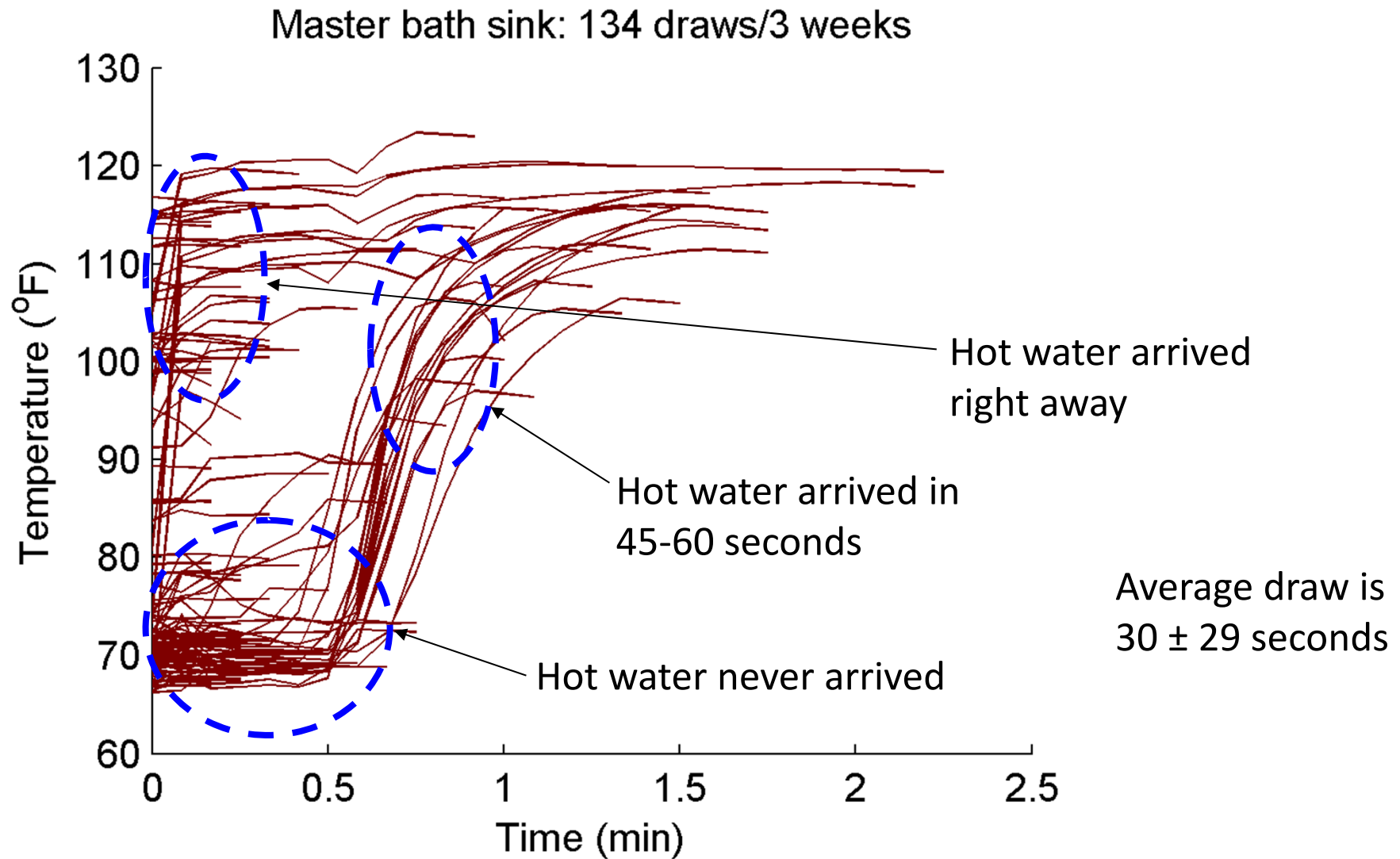

Source: National Renewable Energy Laboratory

How Long Should We Wait?

Volume in the Pipe (ounces)	Minimum Time-to-Tap (seconds) at Selected Flow Rates					
	0.25 gpm	0.5 gpm	1 gpm	1.5 gpm	2 gpm	2.5 gpm
2	4	1.9	0.9	0.6	0.5	0.4
4	8	4	1.9	1.3	0.9	0.8
8	15	8	4	2.5	1.9	1.5
16	30	15	8	5	4	3
24	45	23	11	8	6	5
32	60	30	15	10	8	6
64	120	60	30	20	15	12
128	240	120	60	40	30	24

ASPE Time-to-Tap Performance Criteria

	Acceptable Performance	1 – 10 seconds
	Marginal Performance	11 – 30 seconds
	Unacceptable Performance	31+ seconds

Source: Domestic Water Heating Design Manual – 2nd Edition, ASPE, 2003, page 234

Water Waste as a Function of Flow Rate (Really Velocity)

Flow Rate	$\frac{3}{4}$ inch Nominal Diameter Pipe	
	Relative Water Waste Percent	Approximate Velocity Feet per Second
Greater than 4 gpm	Just over 100%	Greater than 3
4 gpm	110%	2.65
3 gpm	120%	1.99
2 gpm	130%	1.33
1 gpm	150%	0.66
0.5 gpm	Roughly 200%	0.33
0.25 gpm	????	0.17

The velocity of 0.5 gpm in $\frac{3}{4}$ inch nominal pipe is roughly equivalent to the velocity of 2 gpm in 1.5 inch nominal pipe

Gallons Wasted as a Function of Time

and Fixture Flow Rate

(Green < 2 cups), Red >1/2 Gallon)

		Time-to-Tap (Seconds)																								
		1	5	10	15	20	25	30	35	40	45	50	55	60	65	70	75	80	85	90	95	100	105	110	115	120
Flow Rate (GPM)	0.25	0.004	0.021	0.042	0.063	0.083	0.104	0.125	0.15	0.17	0.19	0.21	0.23	0.25	0.27	0.29	0.31	0.33	0.35	0.38	0.40	0.42	0.44	0.46	0.48	0.5
	0.5	0.008	0.042	0.083	0.125	0.17	0.21	0.25	0.29	0.33	0.38	0.42	0.46	0.50	0.54	0.58	0.63	0.67	0.71	0.75	0.79	0.83	0.88	0.92	0.96	1.0
	0.75	0.013	0.063	0.125	0.19	0.25	0.31	0.38	0.44	0.50	0.56	0.63	0.69	0.75	0.81	0.88	0.94	1.0	1.1	1.1	1.2	1.3	1.3	1.4	1.4	1.5
	1	0.017	0.083	0.17	0.25	0.33	0.42	0.50	0.58	0.67	0.75	0.83	0.92	1.0	1.1	1.2	1.3	1.3	1.4	1.5	1.6	1.7	1.8	1.8	1.9	2.0
	1.25	0.021	0.104	0.21	0.31	0.42	0.52	0.63	0.73	0.83	0.94	1.0	1.1	1.3	1.4	1.5	1.6	1.7	1.8	1.9	2.0	2.1	2.2	2.3	2.4	2.5
	1.5	0.025	0.125	0.25	0.38	0.50	0.63	0.75	0.88	1.0	1.1	1.3	1.4	1.5	1.6	1.8	1.9	2.0	2.1	2.3	2.4	2.5	2.6	2.8	2.9	3.0
	1.75	0.029	0.15	0.29	0.44	0.58	0.73	0.88	1.0	1.2	1.3	1.5	1.6	1.8	1.9	2.0	2.2	2.3	2.5	2.6	2.8	2.9	3.1	3.2	3.4	3.5
	2	0.033	0.17	0.33	0.50	0.67	0.83	1.0	1.2	1.3	1.5	1.7	1.8	2.0	2.2	2.3	2.5	2.7	2.8	3.0	3.2	3.3	3.5	3.7	3.8	4.0
	2.25	0.038	0.19	0.38	0.56	0.75	0.94	1.1	1.3	1.5	1.7	1.9	2.1	2.3	2.4	2.6	2.8	3.0	3.2	3.4	3.6	3.8	3.9	4.1	4.3	4.5
	2.5	0.042	0.21	0.42	0.63	0.83	1.0	1.3	1.5	1.7	1.9	2.1	2.3	2.5	2.7	2.9	3.1	3.3	3.5	3.8	4.0	4.2	4.4	4.6	4.8	5
	3	0.05	0.25	0.50	0.75	1.0	1.3	1.5	1.8	2.0	2.3	2.5	2.8	3.0	3.3	3.5	3.8	4.0	4.3	4.5	4.8	5.0	5.3	5.5	5.8	6
	3.5	0.058	0.29	0.58	0.88	1.2	1.5	1.8	2.0	2.3	2.6	2.9	3.2	3.5	3.8	4.1	4.4	4.7	5.0	5.3	5.5	5.8	6.1	6.4	6.7	7
	4	0.067	0.33	0.67	1.0	1.3	1.7	2.0	2.3	2.7	3.0	3.3	3.7	4.0	4.3	4.7	5.0	5.3	5.7	6.0	6.3	6.7	7.0	7.3	7.7	8
	4.5	0.075	0.38	0.75	1.1	1.5	1.9	2.3	2.6	3.0	3.4	3.8	4.1	4.5	4.9	5.3	5.6	6.0	6.4	6.8	7.1	7.5	7.9	8.3	8.6	9
	5	0.083	0.42	0.83	1.3	1.7	2.1	2.5	2.9	3.3	3.8	4.2	4.6	5.0	5.4	5.8	6.3	6.7	7.1	7.5	7.9	8.3	8.8	9.2	9.6	10
	5.5	0.092	0.46	0.92	1.4	1.8	2.3	2.8	3.2	3.7	4.1	4.6	5.0	5.5	6.0	6.4	6.9	7.3	7.8	8.3	8.7	9.2	9.6	10.1	10.5	11
	6	0.100	0.50	1.0	1.5	2.0	2.5	3.0	3.5	4.0	4.5	5.0	5.5	6.0	6.5	7.0	7.5	8.0	8.5	9.0	9.5	10.0	10.5	11.0	11.5	12
	6.5	0.108	0.54	1.1	1.6	2.2	2.7	3.3	3.8	4.3	4.9	5.4	6.0	6.5	7.0	7.6	8.1	8.7	9.2	9.8	10.3	10.8	11.4	11.9	12.5	13
	7	0.117	0.58	1.2	1.8	2.3	2.9	3.5	4.1	4.7	5.3	5.8	6.4	7.0	7.6	8.2	8.8	9.3	9.9	10.5	11.1	11.7	12.3	12.8	13.4	14
	7.5	0.125	0.63	1.3	1.9	2.5	3.1	3.8	4.4	5.0	5.6	6.3	6.9	7.5	8.1	8.8	9.4	10.0	10.6	11.3	11.9	12.5	13.1	13.8	14.4	15
8	0.13	0.67	1.3	2.0	2.7	3.3	4.0	4.7	5.3	6.0	6.7	7.3	8.0	8.7	9.3	10.0	10.7	11.3	12.0	12.7	13.3	14.0	14.7	15.3	16	
8.5	0.14	0.71	1.4	2.1	2.8	3.5	4.3	5.0	5.7	6.4	7.1	7.8	8.5	9.2	9.9	10.6	11.3	12.0	12.8	13.5	14.2	14.9	15.6	16.3	17	
9	0.15	0.75	1.5	2.3	3.0	3.8	4.5	5.3	6.0	6.8	7.5	8.3	9.0	9.8	10.5	11.3	12.0	12.8	13.5	14.3	15.0	15.8	16.5	17.3	18	
9.5	0.16	0.79	1.6	2.4	3.2	4.0	4.8	5.5	6.3	7.1	7.9	8.7	9.5	10.3	11.1	11.9	12.7	13.5	14.3	15.0	15.8	16.6	17.4	18.2	19	
10	0.17	0.83	1.7	2.5	3.3	4.2	5.0	5.8	6.7	7.5	8.3	9.17	10.0	10.8	11.7	12.5	13.3	14.2	15.0	15.8	16.7	17.5	18.3	19.2	20	

Gallons Wasted as a Function of Time and Fixture Flow Rate

(Green < 2 cups), Red >1/2 Gallon)

		Time Until Hot Water Arrives (Seconds)															
		1	2	3	4	5	10	15	20	25	30	35	40	45	50	55	60
Flow Rate (GPM)	0.5	0.01	0.02	0.03	0.03	0.04	0.08	0.13	0.17	0.21	0.25	0.29	0.33	0.38	0.42	0.46	0.50
	1	0.02	0.03	0.05	0.07	0.08	0.17	0.25	0.33	0.42	0.50	0.58	0.67	0.75	0.83	0.92	1.00
	1.5	0.03	0.05	0.08	0.10	0.13	0.25	0.38	0.50	0.63	0.75	0.88	1.00	1.13	1.25	1.38	1.50
	2	0.03	0.07	0.10	0.13	0.17	0.33	0.50	0.67	0.83	1.00	1.17	1.33	1.50	1.67	1.83	2.00
	2.5	0.04	0.08	0.13	0.17	0.21	0.42	0.63	0.83	1.04	1.25	1.46	1.67	1.88	2.08	2.29	2.50
	3	0.05	0.10	0.15	0.20	0.25	0.50	0.75	1.00	1.25	1.50	1.75	2.00	2.25	2.50	2.75	3.00
	3.5	0.06	0.12	0.18	0.23	0.29	0.58	0.88	1.17	1.46	1.75	2.04	2.33	2.63	2.92	3.21	3.50
	4	0.07	0.13	0.20	0.27	0.33	0.67	1.00	1.33	1.67	2.00	2.33	2.67	3.00	3.33	3.67	4.00
	4.5	0.08	0.15	0.23	0.30	0.38	0.75	1.13	1.50	1.88	2.25	2.63	3.00	3.38	3.75	4.13	4.50
	5	0.08	0.17	0.25	0.33	0.42	0.83	1.25	1.67	2.08	2.50	2.92	3.33	3.75	4.17	4.58	5.00
	5.5	0.09	0.18	0.28	0.37	0.46	0.92	1.38	1.83	2.29	2.75	3.21	3.67	4.13	4.58	5.04	5.50
	6	0.10	0.20	0.30	0.40	0.50	1.00	1.50	2.00	2.50	3.00	3.50	4.00	4.50	5.00	5.50	6.00
	6.5	0.11	0.22	0.33	0.43	0.54	1.08	1.63	2.17	2.71	3.25	3.79	4.33	4.88	5.42	5.96	6.50
	7	0.12	0.23	0.35	0.47	0.58	1.17	1.75	2.33	2.92	3.50	4.08	4.67	5.25	5.83	6.42	7.00
	7.5	0.13	0.25	0.38	0.50	0.63	1.25	1.88	2.50	3.13	3.75	4.38	5.00	5.63	6.25	6.88	7.50
	8	0.13	0.27	0.40	0.53	0.67	1.33	2.00	2.67	3.33	4.00	4.67	5.33	6.00	6.67	7.33	8.00
8.5	0.14	0.28	0.43	0.57	0.71	1.42	2.13	2.83	3.54	4.25	4.96	5.67	6.38	7.08	7.79	8.50	
9	0.15	0.30	0.45	0.60	0.75	1.50	2.25	3.00	3.75	4.50	5.25	6.00	6.75	7.50	8.25	9.00	
9.5	0.16	0.32	0.48	0.63	0.79	1.58	2.38	3.17	3.96	4.75	5.54	6.33	7.13	7.92	8.71	9.50	
10	0.17	0.33	0.50	0.67	0.83	1.67	2.50	3.33	4.17	5.00	5.83	6.67	7.50	8.33	9.17	10.00	

1 cup = 8 ounces = 1/16th gallon = 0.0625 gallon

Gallons Wasted as a Function of Time and Fixture Flow Rate

(Green < 2 cups), Red > 1/2 Gallon)

		Time Until Hot Water Arrives (Seconds)															
		1	2	3	4	5	10	15	20	25	30	35	40	45	50	55	60
Flow Rate (GPM)	0.5	0.01	0.02	0.03	0.03	0.04	0.08	0.13	0.17	0.21	0.25	0.29	0.33	0.38	0.42	0.46	0.50
	1	0.02	0.03	0.05	0.07	0.08	0.17	0.25	0.33	0.42	0.50	0.58	0.67	0.75	0.83	0.92	1.00
	1.5	0.03	0.05	0.08	0.10	0.13	0.25	0.38	0.50	0.63	0.75	0.88	1.00	1.13	1.25	1.38	1.50
	2	0.03	0.07	0.10	0.13	0.17	0.33	0.50	0.67	0.83	1.00	1.17	1.33	1.50	1.67	1.83	2.00
	2.5	0.04	0.08	0.13	0.17	0.21	0.42	0.63	0.83	1.04	1.25	1.46	1.67	1.88	2.08	2.29	2.50
	3	0.05	0.10	0.15	0.20	0.25	0.50	0.75	1.00	1.25	1.50	1.75	2.00	2.25	2.50	2.75	3.00
	3.5	0.06	0.12	0.18	0.23	0.29	0.58	0.88	1.17	1.50	1.75	2.04	2.33	2.63	2.92	3.21	3.50
	4	0.07	0.13	0.20	0.27	0.33	0.67	1.00	1.33	1.67	2.00	2.33	2.67	3.00	3.33	3.67	4.00
	4.5	0.08	0.15	0.23	0.30	0.38	0.75	1.13	1.50	1.88	2.25	2.63	3.00	3.38	3.75	4.13	4.50
	5	0.08	0.17	0.25	0.33	0.42	0.83	1.25	1.67	2.08	2.50	2.92	3.33	3.75	4.17	4.58	5.00
	5.5	0.09	0.18	0.28	0.37	0.46	0.92	1.38	1.83	2.29	2.75	3.21	3.67	4.13	4.58	5.04	5.50
	6	0.10	0.20	0.30	0.40	0.50	1.00	1.50	2.00	2.50	3.00	3.50	4.00	4.50	5.00	5.50	6.00
	6.5	0.11	0.22	0.33	0.43	0.54	1.08	1.63	2.17	2.71	3.25	3.79	4.33	4.88	5.42	5.96	6.50
	7	0.12	0.23	0.35	0.47	0.58	1.17	1.75	2.33	2.92	3.50	4.08	4.67	5.25	5.83	6.42	7.00
	7.5	0.13	0.25	0.38	0.50	0.63	1.25	1.88	2.50	3.13	3.75	4.38	5.00	5.63	6.25	6.88	7.50
	8	0.13	0.27	0.40	0.53	0.67	1.33	2.00	2.67	3.33	4.00	4.67	5.33	6.00	6.67	7.33	8.00
8.5	0.14	0.28	0.43	0.57	0.71	1.42	2.13	2.83	3.54	4.25	4.96	5.67	6.38	7.08	7.79	8.50	
9	0.15	0.30	0.45	0.60	0.75	1.50	2.25	3.00	3.75	4.50	5.25	6.00	6.75	7.50	8.25	9.00	
9.5	0.16	0.32	0.48	0.63	0.79	1.58	2.38	3.17	3.96	4.75	5.54	6.33	7.13	7.92	8.71	9.50	
10	0.17	0.33	0.50	0.67	0.83	1.67	2.50	3.33	4.17	5.00	5.83	6.67	7.50	8.33	9.17	10.00	

1 cup = 8 ounces = 1/16th gallon = 0.0625 gallon

Gallons Wasted as a Function of Time and Fixture Flow Rate

(Green < 2 cups), Red > 1/2 Gallon)

		Time Until Hot Water Arrives (Seconds)															
		1	2	3	4	5	10	15	20	25	30	35	40	45	50	55	60
Flow Rate (GPM)	0.5	0.01	0.02	0.03	0.03	0.04	0.08	0.13	0.17	0.21	0.25	0.29	0.33	0.38	0.42	0.46	0.50
	1	0.02	0.03	0.05	0.07	0.08	0.17	0.25	0.33	0.42	0.50	0.58	0.67	0.75	0.83	0.92	1.00
	1.5	0.03	0.05	0.08	0.10	0.13	0.25	0.38	0.50	0.63	0.75	0.88	1.00	1.13	1.25	1.38	1.50
	2	0.03	0.07	0.10	0.13	0.17	0.33	0.50	0.67	0.83	1.00	1.17	1.33	1.50	1.67	1.83	2.00
	2.5	0.04	0.08	0.13	0.17	0.21	0.42	0.63	0.83	1.04	1.25	1.46	1.67	1.88	2.08	2.29	2.50
	3	0.05	0.10	0.15	0.20	0.25	0.50	0.75	1.00	1.25	1.50	1.75	2.00	2.25	2.50	2.75	3.00
	3.5	0.06	0.12	0.18	0.23	0.29	0.58	0.88	1.17	1.46	1.75	2.04	2.33	2.63	2.92	3.21	3.50
	4	0.07	0.13	0.20	0.27	0.33	0.67	1.00	1.33	1.67	2.00	2.33	2.67	3.00	3.33	3.67	4.00
	4.5	0.08	0.15	0.23	0.30	0.38	0.75	1.13	1.50	1.88	2.25	2.63	3.00	3.38	3.75	4.13	4.50
	5	0.08	0.17	0.25	0.33	0.42	0.83	1.25	1.67	2.08	2.50	2.92	3.33	3.75	4.17	4.58	5.00
	5.5	0.09	0.18	0.28	0.37	0.46	0.92	1.38	1.83	2.29	2.75	3.21	3.67	4.13	4.58	5.04	5.50
	6	0.10	0.20	0.30	0.40	0.50	1.00	1.50	2.00	2.50	3.00	3.50	4.00	4.50	5.00	5.50	6.00
	6.5	0.11	0.22	0.33	0.43	0.54	1.08	1.63	2.17	2.71	3.25	3.79	4.33	4.88	5.42	5.96	6.50
	7	0.12	0.23	0.35	0.47	0.58	1.17	1.75	2.33	2.92	3.50	4.08	4.67	5.25	5.83	6.42	7.00
	7.5	0.13	0.25	0.38	0.50	0.63	1.25	1.88	2.50	3.13	3.75	4.38	5.00	5.63	6.25	6.88	7.50
	8	0.13	0.27	0.40	0.53	0.67	1.33	2.00	2.67	3.33	4.00	4.67	5.33	6.00	6.67	7.33	8.00
8.5	0.14	0.28	0.43	0.57	0.71	1.42	2.13	2.83	3.54	4.25	4.96	5.67	6.38	7.08	7.79	8.50	
9	0.15	0.30	0.45	0.60	0.75	1.50	2.25	3.00	3.75	4.50	5.25	6.00	6.75	7.50	8.25	9.00	
9.5	0.16	0.32	0.48	0.63	0.79	1.58	2.38	3.17	3.96	4.75	5.54	6.33	7.13	7.92	8.71	9.50	
10	0.17	0.33	0.50	0.67	0.83	1.67	2.50	3.33	4.17	5.00	5.83	6.67	7.50	8.33	9.17	10.00	

1 cup = 8 ounces = 1/16th gallon = 0.0625 gallon

1- Quart Hot Water Distribution System

Short Trunk – Long Twig

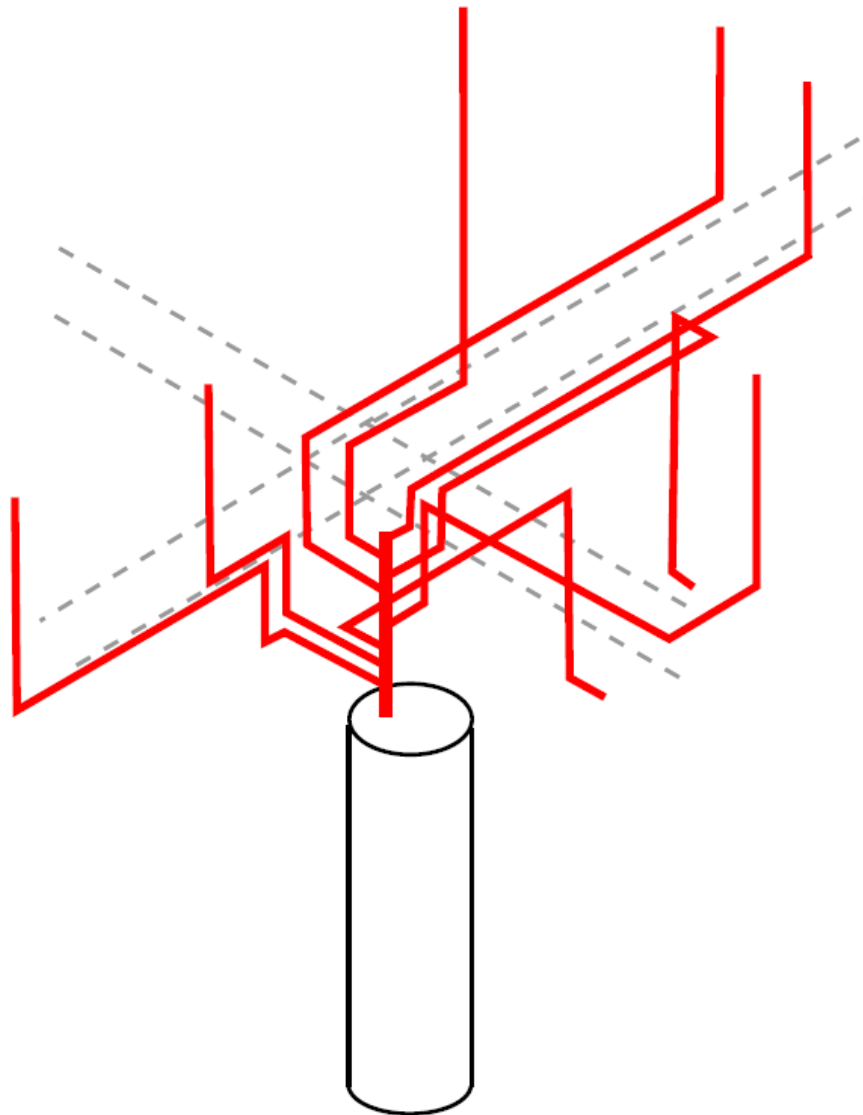

1- Quart Hot Water Distribution System

Long Trunk – Short Twig

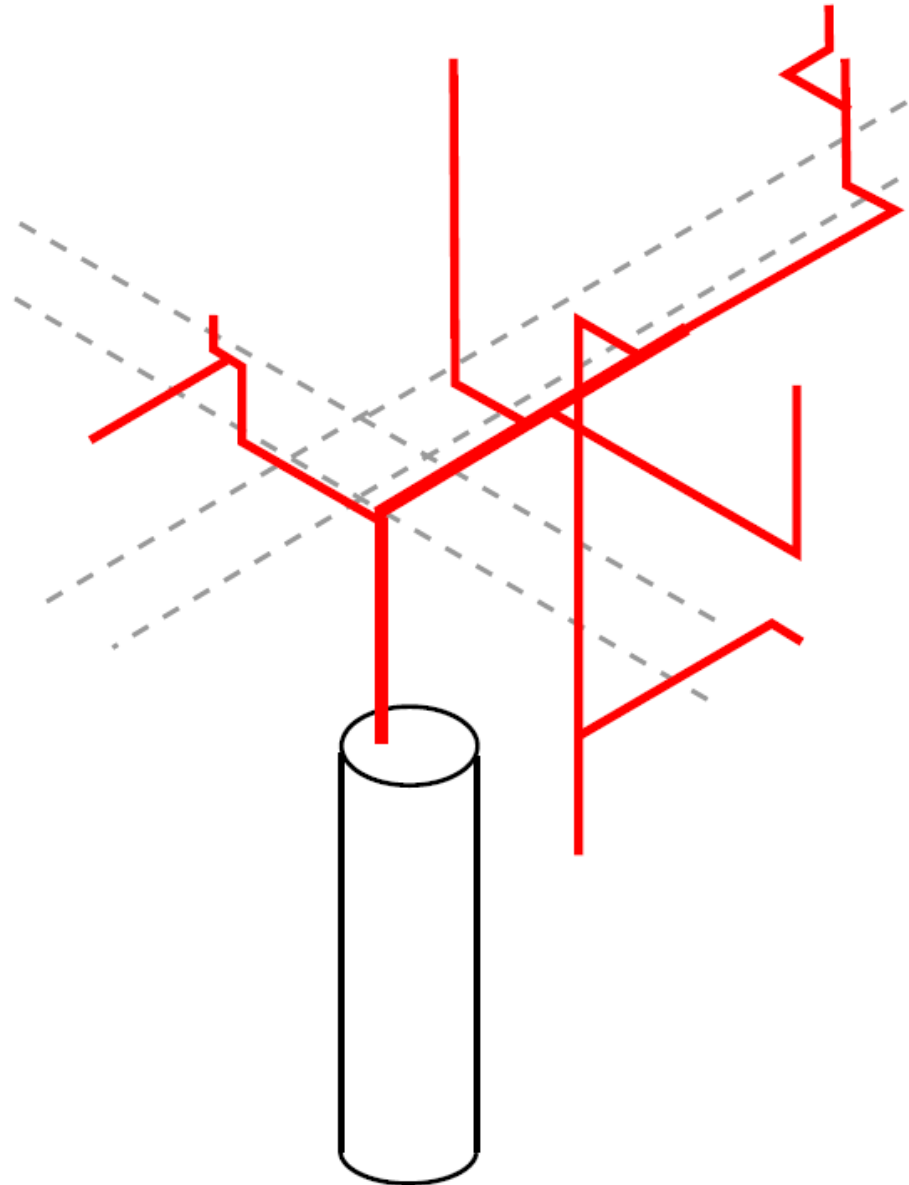

What is the Future of Flow Rates?

Kitchen sinks – 0.5 to 2 gpm (hot only to left, pot fill)

Lavatory sinks – 0.5 gpm (hot only to left)

Showers – 1.5 gpm (water down drain)

Showers – 15 gallons (maximum volume per event)

What impact will these flow rates have on system performance?

Given these flow rates, what impact will the interactions with the rest of the system have on customer satisfaction?

It's All About the Feel!

Not the pressure or flow rate

Lavatory Faucet Stream Patterns

Aerated stream Aerators introduce air into the water stream to produce a larger and whiter stream soft to the touch and non-splashing. Aerators are the usual choice for residential faucet applications.



Laminar stream Laminar stream straighteners produce a non-aerated water stream. Ideal for high flow applications or health care facilities (no mix water/air) laminar spout-end devices deliver a crystal clear and non-splashing stream.



Spray When the flow rate is too low to produce an aerated or laminar stream, a spray device is used to produce a miniature shower pattern to provide full coverage of the hands during washing. Sprays are recommended for use in public lavatories.



Pressure Compensating Aerators

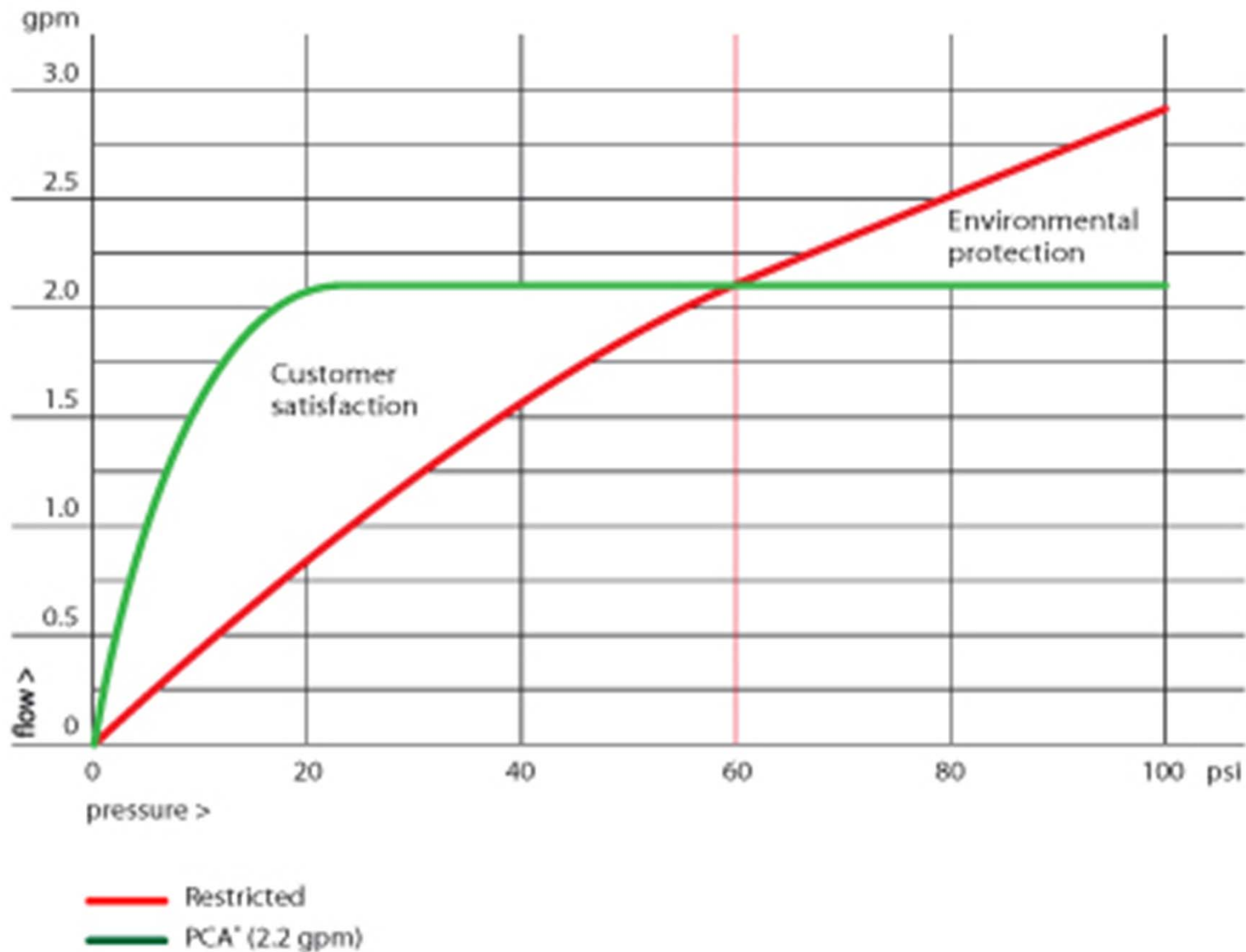

Thank You!

Gary Klein

Affiliated International Management, LLC.

P.O. Box 11752

Newport Beach, CA 92658-5040

Tel: 916-549-7080

Email: gary@aim4sustainability.com